

Edge[®] Controller Communication Manual

For Systems Integrators

Applies to the following AERCO products:

- Benchmark[®] Boilers
- Benchmark Platinum Boilers
- Innovation[®] Water Heaters
- SmartPlate[®] EV Water Heaters

Other documents related to this manual:

OMM-0139, Edge [ii] Controller Operation Manual

OMM-0141, Edge [i] Controller Operation Manual



Disclaimer

The information contained in this manual is subject to change without notice from AERCO International, Inc. AERCO makes no warranty of any kind with respect to this material, including, but not limited to, implied warranties of merchantability and fitness for a particular application. AERCO International is not liable for errors appearing in this manual, not for incidental or consequential damages occurring in connection with the furnishing, performance, or use of these materials.

Heating and Hot Water Solutions

AERCO International, Inc. • 100 Oritani Drive • Blauvelt, NY 10913
USA: T: (845) 580-8000 • Toll Free: (800) 526-0288 • AERCO.com
Technical Support • (800) 526-0288 • Mon-Fri, 8 am - 5 pm EST
© 2023 AERCO

Table of Contents

SECTION 1: INTRODUCTION	3
1.1 TYPES OF COMMUNICATIONS	3
1.2 ETHERNET SECURITY	4
SECTION 2: COMMUNICATION OPTIONS AND MENUS	5
2.1 ETHERNET SETUP MENU FLOW	5
2.2 BAS (BACNET IP) MENU FLOW	6
2.3 BAS (BACNET MSTP) MENU FLOW	7
2.4 BAS (MODBUS TCP) MENU FLOW	8
2.5 BAS (MODBUS RTU) MENU FLOW	9
SECTION 3: WIRING	10
3.1 WIRING ETHERNET	11
3.2 BAS RS-485.....	12
3.3 PROTONODE.....	12
SECTION 4: BAS (BACNET)	13
4.1 BACNET PICS STATEMENT	13
4.2 BACNET OBJECTS LIST	15
4.2.1 BACnet Objects – Stand-Alone or BST Client Units	15
4.2.2 BACnet Objects – BST Manager Only	20
4.2.3 BACnet Objects – BST Client Info Thru BST Manager.....	22
4.2.4 BACnet Point List – SmartPlate and SmartPlate EV.....	23
SECTION 5: BAS (MODBUS)	25
5.1 COMMUNICATION SPECIFICATION	25
5.2 MODBUS POINT LIST.....	25
5.2.1 Modbus Point List – Stand-Alone or BST Client.....	25
5.2.2 Modbus Point List – BST Manager Only	31
5.2.3 Modbus Point List – BST Client Info Thru BST Manager.....	33
5.2.4 Modbus Point List – SmartPlate and SmartPlate EV	35
SECTION 6: FAULT/STATUS CODES	37

SECTION 1: Introduction

Some of the information in this Manual is included in the *Edge [ij] Controller User Manual* (OMM-0139). It is repeated here as a convenience to have all Edge Controller communication setup and testing information needed by Systems Integrators in one location.

The Edge Controller can communicate with a Building Automation System (BAS) using either BACnet® or Modbus®.

1.1 Types of Communications

The Edge Controller is designed with integrated communication as one of its main features. In addition to the I/Os, whether On/Off or analog, it connects to BMS, Smart devices and the cloud using two primary methods:



- Ethernet:
 1. BACnet IP
 2. Modbus TCP
 3. onAER



- RS485:
 1. BACnet MSTP
 2. Modbus RTU
 3. External devices

For LONWorks communication, you will need the ProtoNode connected to the BAS RS-485 terminals on the J3 strip (see Figure 3.1 on page 10 in Section 3).

1.2 Ethernet Security

AERCO always takes security seriously. As a result, the Edge Controller has security options built into its firmware.

Ethernet security is implemented from the BAS screen as follows:

1. Go to: **Main Menu** → **Advanced Setup** → **Comm & Network** → **BAS**.
2. Set the **BAS** parameter to: **BACnet IP** or **Modbus TCP**.
3. the **Security** parameter now appears. Set it to **Enabled**.
4. The **BAS IP** and **BAS MAC** parameters now appear. Enter the server's IP address in the **BAS IP** parameter, and/or the server's MAC address in the **BAS MAC** parameter.

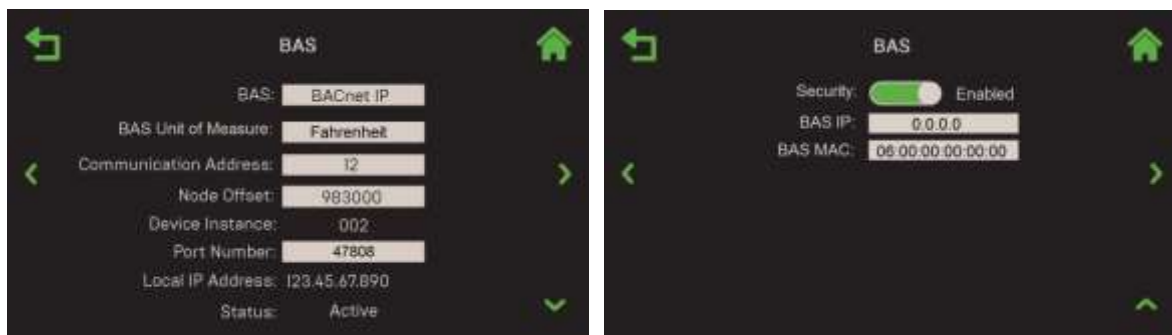

Figure 1.1: BACnet IP Security Screen



Figure 1.2: Modbus TCP Security Screen

SECTION 2: Communication Options and Menus

2.1 Ethernet Setup Menu Flow

The **Ethernet** screen will typically have the DHCP option **Enabled**, and therefore won't require additional configuration. If the DHCP is **Disabled**, the parameters shown below are available for editing with addresses the unit can use to communicate with the network.

NOTE:

Ethernet communication requires an Ethernet cable to be plugged into the Ethernet port on the Controller's left side (see Figure 3.2, in Section 3.1).

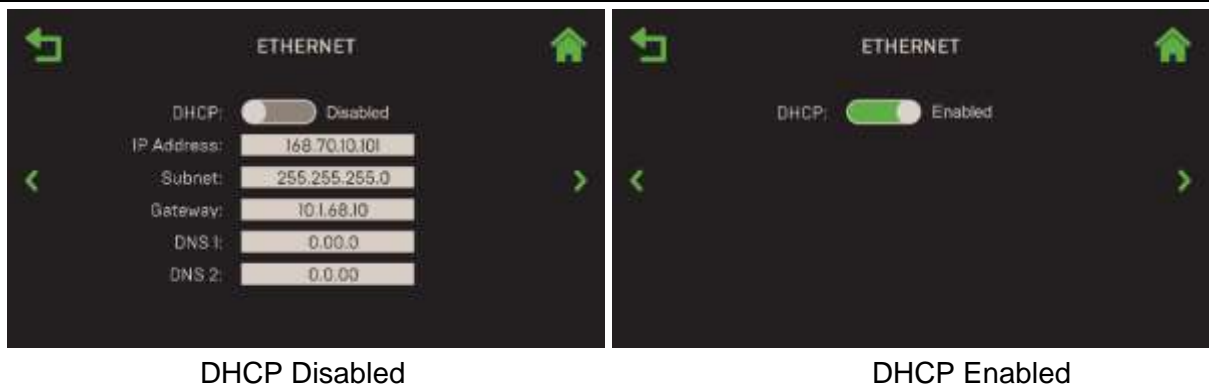

Figure 2.1: Ethernet Screen

1. Go to: **Main Menu** → **Advanced Setup** → **Comm & Network** → **Ethernet**.
2. If **DHCP** is **Disabled**, manually enter the communication parameters, typically provided by a network administrator, in the available fields:
 - IP Address
 - Subnet
 - Gateway
 - DNS 1
 - DNS 2

2.2 BAS (BACnet IP) Menu Flow

The communication parameters for **BACnet IP** interface are in the Controller's **BAS** screen.

1. Go to: **Main Menu** → **Advanced Setup** → **Comm & Network** → **BAS**.

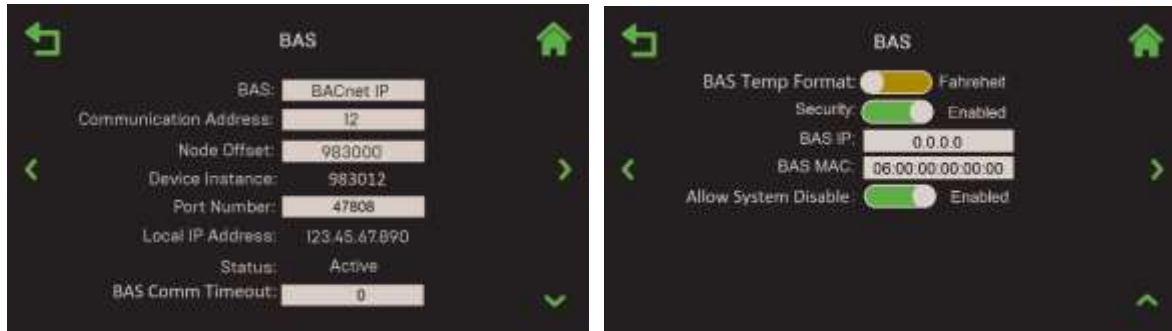

Figure 2.2: BAS Screen – BACnet IP

2. The default is **Off**. To enable BACnet IP communication with a BAS, press **BAS** and choose **BACnet IP**.
3. The following parameters now appear:
 - **Communication Address:** Specify the network address of the Edge Controller. (Range: 0 to 127)
 - **Node Offset:** The starting root BACnet address for the group of devices.
 - **Device Instance:** Identifies the device on a BACnet network. It is generated from the **Node Offset** added to the **Communication Address** field. This value must be unique on a BACnet network.
 - **Port Number:** Specify the BAS port to which the unit will communicate. (Range: 47808 to 47823)
 - **Local IP Address:** Displays the local IP address.
 - **Status:** Displays the status of BAS communications.
 - **BAS Comm Timeout:** Specifies the BAS communication timeout period.
 - **BAS Temp Format:** Choose **Fahrenheit** or **Celsius**.
 - **Security:** Choose whether to **Enable** or **Disable** security. If enabled, the following parameters appear:
 - **BAS IP:** Secure communication to BAS server based on IP address.
 - **BAS MAC:** Secure communication to BAS server based on MAC address.

2.3 BAS (BACnet MSTP) Menu Flow

The communication parameters for **BACnet MSTP** interface are in the Controller's **BAS** screen.

1. Go to: **Main Menu** → **Advanced Setup** → **Comm & Network** → **BAS**.
2. The default is **Off**. To enable BACnet MSTP communication with a BAS, press **BAS** and choose **BACnet MSTP**.
3. The following parameters now appear:
 - **Baud Rate:** Choose one: **9600, 19200, 38400, 57600, 76800** or **115200**.
 - **Communication Address:** Specify the network address of the Edge Controller. (Range: 0 to 127)
 - **Node Offset:** The starting root BACnet address for the group of devices
 - **Device Instance:** Identifies the device on a BACnet network. It is generated from the **Node Offset** added to the **Communication Address** fields. This value must be unique on a BACnet network.
 - **Status:** Displays the status of BAS communications.
 - **BAS Comm Timeout:** Specifies the BAS communication timeout period.
 - **BAS Temp Format:** Choose **Fahrenheit** or **Celsius**.

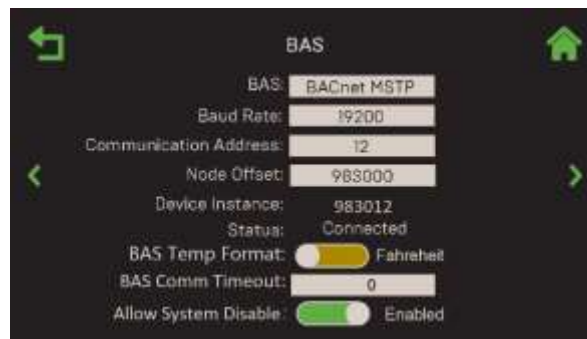

Figure 2.3: BAS Screen – BACnet MSTP

The following table lists Serial Port settings for all Edge RS485 communications:

Serial Port Setting	Value
Parity	None
Data Bits	8
Start or Stop Bit	1

2.4 BAS (Modbus TCP) Menu Flow

The communication parameters for **Modbus TCP** interface are in the Controller's **BAS** screen.

1. Go to: **Main Menu** → **Advanced Setup** → **Comm & Network** → **BAS**.
2. The default is **Off**. To enable Modbus TCP communication with a BAS, press **BAS** and choose **Modbus TCP**.
3. The following parameters now appear:
 - **Communication Address:** Specify the network address of the Edge Controller. (Range: 0 to 127)
 - **Local IP Address:** Displays the local IP address.
 - **Status:** Displays the status of BAS communications.
 - **BAS Comm Timeout:** Specifies the BAS communication timeout period.
 - **BAS Temp Format:** Choose Fahrenheit or Celsius.
 - **Security:** Choose whether to **Enable** or **Disable** BAS Security. If enabled, the following additional parameters appear:
 - **BAS IP:** Secure communication to BAS server based on IP address.
 - **BAS MAC:** Secure communication to BAS server based on MAC address.

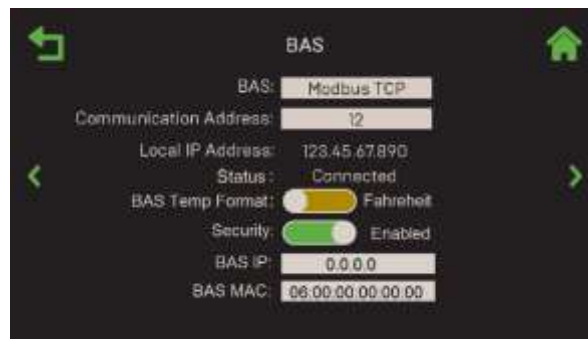

Figure 2.4: BAS Screen – Modbus TCP

2.5 BAS (Modbus RTU) Menu Flow

The communication parameters for **Modbus RTU** interface are in the Controller's **BAS** screen.

1. Go to: **Main Menu** → **Advanced Setup** → **Comm & Network** → **BAS**.
2. The default is **Off**. To enable Modbus RTU communication with a BAS, press **BAS** and choose **Modbus RTU**.
3. The following parameters now appear:
 - **Baud Rate**: Choose one: **9600, 19200, 38400, 57600, 76800** or **115200**.
 - **BAS Unit of Measurement**: Choose **Fahrenheit, Celsius** or **Points**.
 - **Communication Address**: Specify the network address of the Edge Controller. (Range: 0 to 127)
 - **Status**: Displays the status of BAS communications.
 - **BAS Comm Timeout**: Specifies the BAS communication timeout period.
 - **BAS Temp Format**: Choose Fahrenheit or Celsius.

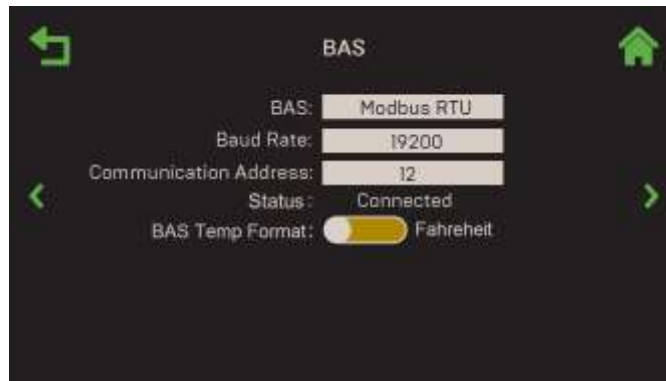

Figure 2.5: BAS Screen – Modbus RTU

The following table lists Serial Port settings for all Edge RS485 communications:

Serial Port Setting	Value
Parity	None
Data Bits	8
Start or Stop Bit	1

SECTION 3: Wiring

The Edge Controller can communicate directly with a BAS using either Modbus or BACnet protocols over either Serial RS-485 or Ethernet TCP/IP. They connect to the unit's I/O board as shown below.

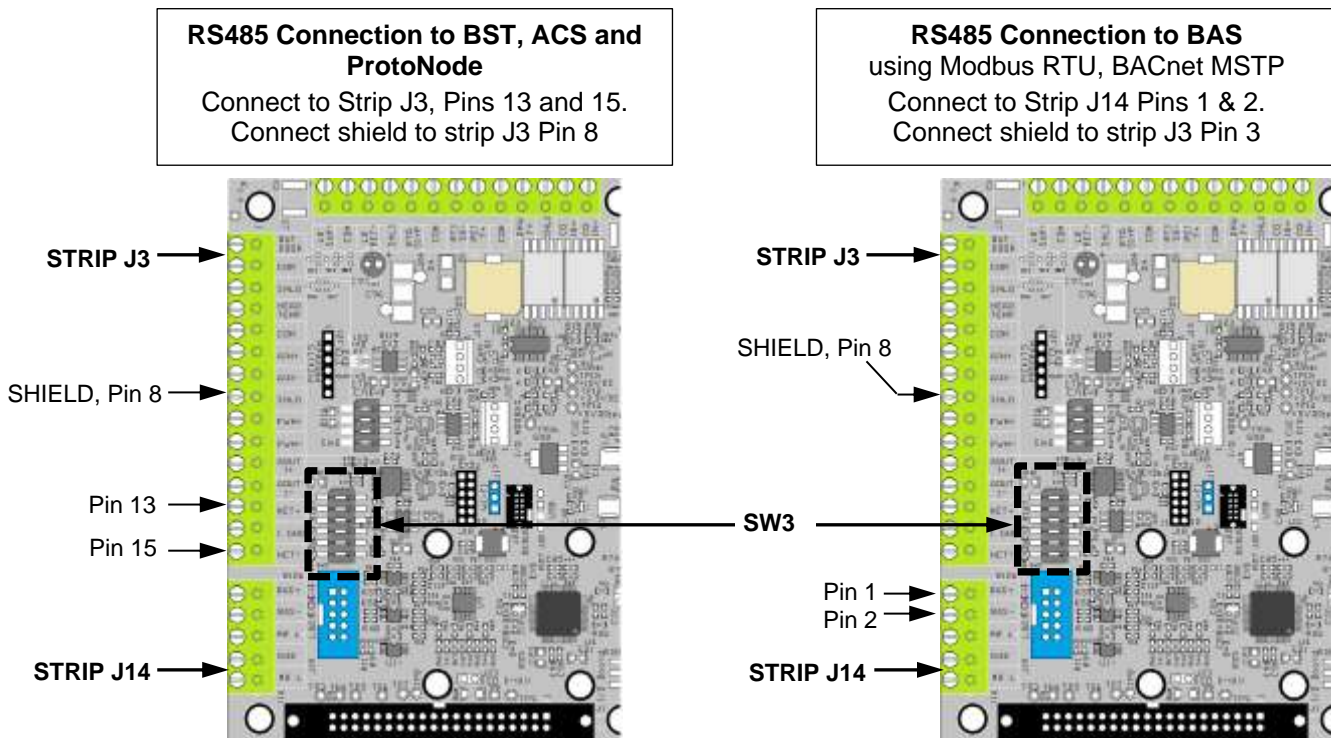

Figure 3.1: Benchmark Platinum-Edge I/O Board

The I/O board contains the terminal listed below, arranged on removable, connector terminal strips J3 through J7, and J14. Terminal names are printed on the board and the I/O Board cover label.

The maximum gauge of wires connecting to the I/O board is 14.

NOTES:

POWER DOWN THE UNIT BEFORE MAKING ANY CONNECTIONS.

To facilitate making the connections, these strips can be lifted off the I/O board. The entire strip is then remounted on the I/O board after all connections have been made. If a connector strip is removed, it must be re-mounted in its original orientation with connecting wires arranged around the **outside** perimeter of the I/O board.

DIP switch block SW3 numbers 1-3 apply to Strip J3, BST RS485 terminals.

DIP switch block SW3 numbers 4-6 apply to Strip J14 BAS RS485 terminals. Set them as follows:

- For BAS RS485 wiring termination, set **SW3** switch 5 to **ON** only on the BAS controls and the last equipment on the daisy chain.
- All other units must have this DIP switch set to **OFF**.

It is recommended to connect BAS wirings to the Backup Manager.

SECTION 3: WIRING

- If the Manager fail-over occurs, then the Backup Manager is ready to handle the BAS communication.

Connector Strip J3 Terminals		
Pin #	Name	Description
8	RS485 Iso Gnd	Dedicated to internal communication between units in a BST or WHM system. ACS (legacy) panel should also be connected to this terminal.
13	BST/WHM RS485 +	
15	BST/WHM RS485 -	

Connector Strip J14 Terminals		
Pin #	Name	Description
1	BAS RS485 +	Connection to the building automation system (BAS) network (Modbus RTU, BACnet MSTP). For IP network, use the Ethernet port.
2	BAS RS485 -	

3.1 Wiring Ethernet

The following shows the location of the Ethernet port, on the Controller’s left side (remove front panel to gain access). There are conduit knockout holes on the top of the unit sheet metal.

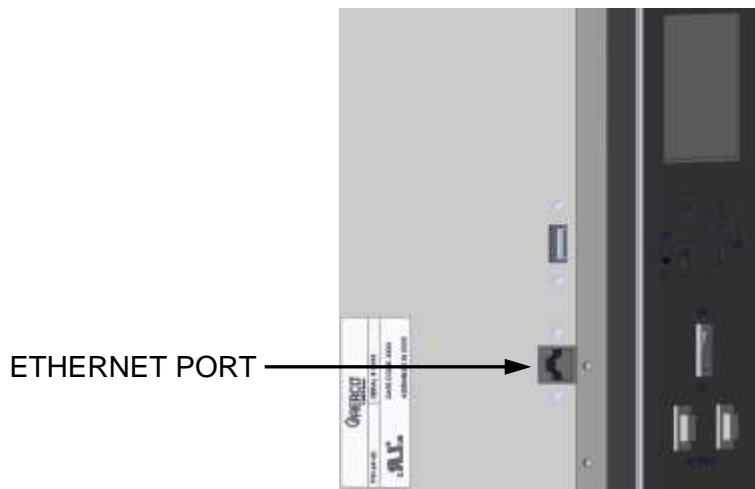

Figure 3.2: USB & Ethernet Port Locations

When connecting a BAS to the Edge Controller using Ethernet, make sure the BAS is on the same LAN as the Edge Controller.

There are additional security settings necessary for TCP/IP communications in the Ethernet screen (Go to: **Main Menu** → **Advanced Setup** → **Comm & Network** → **Ethernet**). The communication parameters appear when **DHCP** is manually set to **Disabled**.

SECTION 3: WIRING



Figure 3.3: Ethernet Screen

3.2 BAS RS-485

When connecting a BAS to a BST Manager using RS-485, connect to the unit’s I/O Board connector strip **J14**, pins 1 and 2, as shown in Figure 3.1. The Edge communicates at one of the following baud rates: **9600, 19200, 38400** or **115200**.

The BST Manager supports either Modbus or BACnet protocols over either Serial RS-485 or Ethernet TCP/IP.

Connector Strip J14 Terminals		
Pin #	Name	Description
1	BAS RS485 +	Connection to the building automation system (BAS) network (Modbus RTU, BACnet MSTP). For IP network, use the Ethernet port.
2	BAS RS485 -	
3	RS485 Local +	Reserved for internal use only
4	RS485 Ground	
5	RS485 Local -	

NOTE:

When connecting the BAS RS485, Biasing must be calculated and applied externally. Termination needs to be applied by setting DIP switch block SW3 switch #5 to **ON** (Termination Enabled) only to the first and last unit on a BAS RS485 wiring (see Figure 3-1). All other units must have this DIP switch set to **OFF**.

3.3 ProtoNode

For protocols other than BACnet and Modbus a ProtoNode is required. See the **OMM-0107 GF-150 ProtoNode FPC N34-N35 User Manual** for details.

SECTION 4: BAS (BACnet)

The BST Manager Edge Controller provides BAS information for the entire plant using a single connection. The register values are listed below. It supports either Modbus or BACnet protocols over either Serial RS-485 or Ethernet TCP/IP.

4.1 BACnet PICS Statement

BACnet Protocol Implementation Conformance Statement

Date: 9/27/2018

Vendor Name: AERCO International (BACnet Vendor ID: 983)

Product Name: EDGE

Product Model Number: _____

Application Software Version: 1.0 Firmware Revision: _____ BACnet Protocol Revision: 12

Product Description:

The Edge controller is an integrated boiler and water heater controller for AERCO products. It is designed to sequence boilers and water heaters while improving overall system efficiency and simplifying design, installation, startup and maintenance.

BACnet Standardized Device Profile (Annex L):

- BACnet Operator Workstation (B-OWS)
- BACnet Advanced Operator Workstation (B-AWS)
- BACnet Operator Display (B-OD)
- BACnet Building Controller (B-BC)
- BACnet Advanced Application Controller (B-AAC)
- BACnet Application Specific Controller (B-ASC)
- BACnet Smart Sensor (B-SS)
- BACnet Smart Actuator (B-SA)

List all BACnet Interoperability Building Blocks Supported (Annex K): _____

Segmentation Capability:

- Able to transmit segmented messages Window Size _____
- Able to receive segmented messages Window Size _____

Standard Object Types Supported:

An object type is supported if it may be present in the device. For each standard Object Type supported provide the following data:

- 1) Whether objects of this type are dynamically creatable using the CreateObject service
- 2) Whether objects of this type are dynamically deletable using the DeleteObject service
- 3) List of the optional properties supported
- 4) List of all properties that are writable where not otherwise required by this standard
- 5) List of all properties that are conditionally writable where not otherwise required by this standard

SECTION 4: BAS (BACnet)

- 6) List of proprietary properties and for each its property identifier, datatype, and meaning
- 7) List of any property range restrictions

Data Link Layer Options:

- BACnet IP, (Annex J)
- BACnet IP, (Annex J), Foreign Device
- ISO 8802-3, Ethernet (Clause 7)
- ATA 878.1, 2.5 Mb. ARCNET (Clause 8)
- ATA 878.1, EIA-485 ARCNET (Clause 8), baud rate(s) _____
- MS/TP master (Clause 9), baud rate(s): _____
- MS/TP slave (Clause 9), baud rate(s): _____
- Point-To-Point, EIA 232 (Clause 10), baud rate(s): _____
- Point-To-Point, modem, (Clause 10), baud rate(s): _____
- LonTalk, (Clause 11), medium: _____
- BACnet/ZigBee (ANNEX O)
- Other: _____

Device Address Binding:

Is static device binding supported? (This is currently necessary for two-way communication with MS/TP slaves and certain other devices.) Yes No

Networking Options:

- Router, Clause 6 - List all routing configurations, e.g., ARCNET-Ethernet, Ethernet-MS/TP, etc.
- Annex H, BACnet Tunneling Router over IP
- BACnet/IP Broadcast Management Device (BBMD)
 - Does the BBMD support registrations by Foreign Devices? Yes No
 - Does the BBMD support network address translation? Yes No

Network Security Options:

- Non-secure Device - is capable of operating without BACnet Network Security
- Secure Device - is capable of using BACnet Network Security (NS-SD BIBB)
 - Multiple Application-Specific Keys:
 - Supports encryption (NS-ED BIBB)
 - Key Server (NS-KS BIBB)

Character Sets Supported:

Indicating support for multiple character sets does not imply that they can all be supported simultaneously.

- ISO 10646 (UTF-8)
- IBM™/Microsoft™ DBCS
- ISO 8859-1
- ISO 10646 (UCS-2)
- ISO 10646 (UCS-4)
- JIS X 0208

SECTION 4: BAS (BACnet)

4.2 BACnet Objects List

BACnet communication objects are in the following Sections, below:

4.2.1 – BACnet Objects – Stand-Alone or BST Client

4.2.2 – BACnet Objects – BST Manager Only

4.2.3 – BACnet Objects – Client Info Thru Manager

4.2.1 BACnet Objects – Stand-Alone or BST Client Units

TABLE 4-1: BACnet Objects – Stand-Alone or BST Client – Object Type = AI, Read Only						
BACnet ID	Object Name	Min	Max	BMK Edge[ii]	BMK Edge[i]	INN Edge[i]
0	Message Code	See Table 6 in Section 6: <i>Fault/Status Codes</i>				
1	Unit Status	0 = Disabled 1 = Standby 2 = Manual	3 = Remote 4 = Auto 5 = Fault			
2	Outlet:	0	250F			
3	Lower Inlet:	0	250F			
4	Air Inlet:	-70	130F			
5	Outside Temp:	-70	130F			
6	Exhaust:	50	450			
7	Feed Forward:	0	250F			
8	Current Valve Position:	0	100			
9	O2:	0	24.00%			NA
10	Supply Gas Pressure:	Unused except for C-More compatibility		NA	NA	NA
11	Run Cycles:	0	999,999,999			
13	Run Hours:	0	999,999,999			
15	Flame Strength:	0	100			
16	Active Setpoint Temp:	0	250F			
17	PID Output	0	100			
18	SET Valve Position	0	100			
19	Communication Address:	0	255			
44	Select Output:	0 = Standard Setup 1 = Cascade Valve 2 = Aout 2				
45	Control Mode:	0 = On/Off 1 = Linear Modulation 2 = Delta T Modulation				
46	Isolation Feedback:	disable	enable			
47	Open Vlv Control Signal:	0 = 0mA 1 = 4mA 2 = 20mA				
48	Close Vlv Control Signal:	0 = 0mA, 1 = 4mA, 2 = 20mA				

SECTION 4: BAS (BACnet)

TABLE 4-1: BACnet Objects – Stand-Alone or BST Client – Object Type = AI, Read Only						
BACnet ID	Object Name	Min	Max	BMK Edge[ii]	BMK Edge[i]	INN Edge[i]
49	Blower Speed	0	65536		NA	NA
50	Blower Pulses/Rev:	0	100		NA	NA
51 – 58	O2 Target 1 – O2 Target 8	3%	8%			NA
59	O2 Error Code1	0-0-0-0-0-0-0-0	9-9-9-9-9-9-9-9			NA
60	O2 Error Code2	0-0-0-0-0-0-0-0	9-9-9-9-9-9-9-9			NA
61	O2 Timer	0 = 2 Hour On, 1 = 4 Hour On, 2 = 10 Hour Off (not in use)		NA	NA	NA
62	bst uart3 errors	0 = No errors 1 = Overrun Error 2 = Framing Error 3 = Parity Error 4 = Uart Sync Error 5 = CRC Error 6 = Unknown Error				
63	Nox Requirement	0	200			
64	Manifold Gas Pressure	0	90			
65 – 72	O2 at Cal Point 1 to O2 at Cal Point 8	0	99.9			
73 – 80	NOx at Cal 1 to NOx at Cal 8	0	999			
81 – 88	CO at Cal 1 to CO at Cal 8	0	999			
89 – 96	Flame Strength at Cal 1 to Flame Strength at Cal 8	0	99.9			
97	Time	12.00am	11.59pm			
98	Date	0/0/0	12/31/9999			
99 – 106	Previous O2 at Cal 1 to Previous O2 at Cal 8	0	99.9			
107 – 114	Previous NOx at Cal 1 to Previous NOx at Cal 8	0	999			
115 – 122	Previous CO at Cal 1 to Previous CO at Cal 8	0	999			
123 – 130	Previous CAL Point 1 to Previous CAL Point 8	0	100			
131 – 138	Pre Flame Strength at Cal 1 to Pre Flame Strength at Cal 8	0	99.9			
139	SmartPlate Outlet	0	250F			NA
140	SmartPlate Valve Pos	0	100			NA
141	SmartPlate Setpoint	0	200F			NA
142	SmartPlate Error Number	0	5			NA
143	SmartPlate Pmp Unit Addr	0	255			NA
144	SmartPlate Start Address	50	54			NA
145	Number of SmartPlates	0	6			NA
146	Current Blower Voltage	0	10v			
147	Software Version	00.00.000	99.99.999			
148	Unit Alpha	0=E, 1=G, 2=H, 3=R, 4=N, 5=A				
149	Unit Year	0	99			

SECTION 4: BAS (BACnet)

TABLE 4-1: BACnet Objects – Stand-Alone or BST Client – Object Type = AI, Read Only						
BACnet ID	Object Name	Min	Max	BMK Edge[ii]	BMK Edge[i]	INN Edge[i]
150	Unit Serial #	0	9999			
151	Fuel Type	0=Natural Gas	1=Propane			
152	Unit Mode	0=OFF, 1=Client, 2=Manager				

TABLE 4-2: BACnet Objects – Stand-Alone or BST Client – Object Type = AV, Read/Write						
BACnet ID	Object Name	Min	Max	BMK Edge[ii]	BMK Edge[i]	INN Edge[i]
0	Net Remote Setpt	0	9999			
1	Net Direct Drive	0	9999			NA
2	Remote Password	0, 1, 2, 3, 4, 5				
3	Password	0, 1, 2, 3, 4, 5				
4	SH Setpoint:	20F	245F			
5	Language:	0 = English, 1 = Spanish, 2 = French				
6	Time:	12.00am	11.59pm			
7	Date:	0/0/0	12/31/9999			
8	Unit of Measurement:	English	Metric			
9	Cascade Baud Rate	0 = 9600 1 = 19200 2 = 38400	3 = 57600 4 = 76800 5 = 115200			
10	Unit Type:	0 = KC Boiler 1 = KC Boiler LN 2 = BMK Boiler Std 3 = BMK Blr Std Dual 4 = BMK Boiler LN 5 = BMK Blr LN Dual	6 = KC Water Heater 7 = KC Water Heater LN 8 = Innovation 9 = Innovation N			
11	Unit Size:	0 = SPARE 1 = 600 MBH 2 = 800 MBH 3 = 1060 MBH 4 = 1350 MBH 5 = 500 MBH 6 = 750 MBH 7 = 1000 MBH 8 = 1.5 MBTU	9 = 1500 MBH 10 = 2.0 MBTU 11 = 2000 MBH 12 = 2500 MBH 13 = 3.0 MBTU 14 = 3000 MBH 15 = 4000 MBH 16 = 5000 MBH 17 = 6000 MBH			
12	SH Operating Mode	0 = Constant Setpt 1 = Remote Setpt 2 = Direct Drive 3 = Combination 4 = Outdoor Reset				
13	Remote Signal	0 = 4-20mA/1-5V 1 = 0-20mA/0-5V 2 = Network 3 = BAS 4 = BST (PWM) Input				
16	Outdoor Sensor	Disable	Enable			NA
17	Warm Weather Shtdwn:	30F	210F			NA

SECTION 4: BAS (BACnet)

TABLE 4-2: BACnet Objects – Stand-Alone or BST Client – Object Type = AV, Read/Write						
BACnet ID	Object Name	Min	Max	BMK Edge[ii]	BMK Edge[i]	INN Edge[i]
18	Setpoint Low Limit:	40F	245F			
19	Setpoint High Limit:	20F	220F			
20	Temperature High Limit:	40F	210F			
21	Max Valve Position:	40	100			
22	Pump Off Delay	0	30			
23	Auxiliary Delay:	0	240			
24	Unit Failsafe Mode	0 = Shutdown, 1 = Constant Setpt				
25	Low Fire Timer:	2sec	600Sec			
26	Proportional Band:	1F	120F			
27	Integral Band:	0	2			
28	Derivative Band:	0	2min			
29	Min Load Adj	-50	50F			
30	Max Load Adj	-50	50F			
31	Outlet Feedback	No	Yes			
32	Feedback Gain	0.01	1			
33	Breakpt at 0%	-100	100F			
34	Breakpt at 10%	-100	100F			
35	Breakpt at 20%	-100	100F			
36	Breakpt at 30%	-100	100F			
37	Breakpt at 40%	-100	100F			
38	Breakpt at 50%	-100	100F			
39	Breakpt at 60%	-100	100F			
40	Breakpt at 70%	-100	100F			
41	Breakpt at 80%	-100	100F			
42	Breakpt at 90%	-100	100F			
43	Breakpt at 100%	-100	100F			
44	Purge Timer:	5Sec	60Sec			
45	Post Purge Timer:	0	60Sec			
46	Ignition Position:	5%	60%			
47	Stop Valve Position:	0	40%			
48	Start Valve Position:	0	40%			
49	On Delay:	0	600Sec			
50	Max Flow	10gpm	500gpm			
53	FFWD Temp Display	Disable	Enable			
54	Flow Rate Disply	Disable	Enable			
57	Valve Pos Out Dsp	Disable	Enable			
58	Exhaust Temp Dsp	Disable	Enable			
59	Setpoint Limiting:	Disable	Enable			
60	Setpoint Limit Band:	0	10F			
61	Temp Comp Adjust	None	Run Cycles			

SECTION 4: BAS (BACnet)

TABLE 4-2: BACnet Objects – Stand-Alone or BST Client – Object Type = AV, Read/Write						
BACnet ID	Object Name	Min	Max	BMK Edge[ii]	BMK Edge[i]	INN Edge[i]
62	Inlet Temp Display	Disable	Enable			
63	Power Reset:	Manual	Automatic			
64	Water Temp Reset:	Manual	Automatic			
65	Gas Pressure Reset:	Manual	Automatic			
66	Sensor Log Int	0 = Off 1 = 1 min 2 = 5 min 3 = 15 min 4 = 30 min	5 = 1 hr 6 = 6 hrs 7 = 12 hrs 8 = 24 hrs			
70	BAS:	0 = Off 1 = BACnet MSTP 2 = BACnet IP 3 = Modbus RTU 4 = Modbus TCP				
71	Cascade Baud Rate	0 = 9600 1 = 19200	2 = 38400 3 = 57600			
72	INTL Communication	Disable	Enable			
73	Intl Baud Rate	0 = 9600 1 = 19200 2 = 38400	3 = 57600 4 = 76800 5 = 115200			
74	onAER Menu	0 = Disabled 1 = Ethernet	2 = Wi-Fi 3 = Wiznet			
75	AERtrim	Disabled	Enabled			NA
76	O2 Monitoring:	Disabled	Enabled	NA	NA	NA
77	SmartPlate Setpoint:	0	140F			NA
78	SP Pump Out Signal	0	10V			NA
79	SmartPlate Pmp Unit Addr	Disabled	Enabled			NA
80	Remote Disable Code (Advanced Setup → Comm & Network → BAS, Allow System Disable = Yes)	0 = Enable Unit	85 = Disable Unit			
81	Outdoor Air Temp Sens	0=Network, 1=Direct, 2=BAS				NA
82	OAT BAS Temp	0	250F			NA

SECTION 4: BAS (BACnet)

4.2.2 BACnet Objects – BST Manager Only

TABLE 4-3: BACnet Objects – BST Manager Only – Object Type = AI, Read Only						
BACnet ID	Object Name	Min	Max	BMK Edge[ii]	BMK Edge[i]	INN Edge[i]
100	Unit Mode:	0 = Off 1= BST Client 2= BST Manager				
101	Plant Constant Setpoint:	20F	245F			
102	Setback Setpoint:	20F	245F			
103	Setback Start Time:	12.00am	11.59pm			
104	Setback Stop Time:	0/0/0	12/31/9999			
105	Auto-Manager Transfer:	Disabled	Enabled			
106	OutletTemp	0F	250F			
107	UEnabled	0	16			
108	Units Faulted	0	16			
109	Unit Address:	0	16			
110	Header Temp	0F	250F			NA
111	BST Outdoor Temp	-70	130F			NA
112	BST Fire Rate	0	100%			NA
113	Units Ignited	0	16			
114	Act Setpt	0F	250F			
115	SH Next On Valve Pos:	16%	100%			NA
116	BST Setpt Hi Lim	20F	220F			NA
117	BST Setpt Low Limit:	40F	245F			NA
118	Cascade Temp Hi Limit:	40F	210F			
119	SH Operating Mode	0 = Constant Setpoint 1 = Rmt Stpt 2 = Outdoor Air Reset				
120	DHW Header Temp	0	245F		NA	NA
121	DHW Setpoint	40F	245F		NA	NA
122	Fuel Type	0 = Natural Gas, 1 = Propane				
123	VSP Pump Output	0V	10V		NA	NA
124	VSP Pump Relay	Off	On		NA	NA
125	Loop Return Temp	40F	245F		NA	NA
126	DHW Header Temp	40F	245F		NA	NA
127	SmartPlate Outlet	40F	245F			NA
128	SmartPlate Valve Pos	0%	100%			NA
129	SmartPlate Setpoint	0F	140F			NA
130	SmartPlate Error Number	0	10			NA
131	SmartPlate Pmp Unit Addr	0	16			NA
132	SmartPlate Start Address	50	54			NA

SECTION 4: BAS (BACnet)

TABLE 4-3: BACnet Objects – BST Manager Only – Object Type = AI, Read Only						
BACnet ID	Object Name	Min	Max	BMK Edge[ii]	BMK Edge[i]	INN Edge[i]
133	Number of SmartPlates	0	6			NA
134 – 151	Not Used			NA	NA	NA
152	Unit Mode	0=OFF, 1=Client, 2=Manager				

TABLE 4-4: BACnet Objects – BST Manager Only – Object Type = AV, Read/Write						
BACnet ID	Object Name	Min	Max	BMK Edge[ii]	BMK Edge[i]	INN Edge[i]
51	Allow BAS to Write	0	1			
53	Network Timeout:	5sec	999sec			
200	Plant Remote Setpoint:	20F	245F			
201	Setback Setpoint:	20F	245F			
202	Setback Start Time:	12.00am	11.59pm			
203	Setback Stop Time:	12.00am	11.59pm			
204	Setback Schedule:	Disable	Enable			
205	DHW Temp Sensor:	0 = OFF, 1 = Network, 2 = Direct, 3 = BAS			NA	NA
206	DHW Header Temp:	0F	250F		NA	NA
207	DHW Operating Mode:	0 = Constant Setpoint, 1 = Remote Setpoint			NA	
208	DHW Rmt Setpt Signal:	0 = 1-5V, 1 = 0-5V, 2 = Network, 3 = BAS			NA	NA
209	DHW BAS Remote Setpoint	40F	245F		NA	NA
210	Other SH PRI Setpt Mode	0 = Constant Setpoint, 1 = Remote Setpoint			NA	NA
211	Other SH PRI Remote Signl	0 = 1-5V, 1 = 0-5V, 2 = Network, 3 = BAS			NA	NA
212	Other SH PRI Setpoint	20F	245F		NA	NA
213	Hdr Temp Sensor	0 = Network 1 = FFWD Temp 2 = Direct 3 = BAS 4 = OFF				NA
214	BAS Header Temp	0F	250F			NA
215	Rtn Hdr Temp Sensor	OFF (0), Network (1), Direct (2), BAS (3)				NA
216	Rtn Hdr Temp Sensor	0F	250F			NA
217	Outdoor Air Temp Sens	Network (0), Direct (1), BAS(2), OFF (3)				NA
218	OAT BAS Temp	0F	250F			NA
219	BAS	0 = OFF 1 = BACnet MSTP 2 = BACnet IP	3 = Modbus RTU 4 = Modbus TCP			
220	Baud Rate	0 = 9600 1 = 19200	2 = 38400 3 = 57600			
221	INTL Communication	0 = Disabled 1 = Enabled				
222	Intl Baud Rate	0 = 9600 1 = 19200	2 = 38400 3 = 57600			

SECTION 4: BAS (BACnet)

TABLE 4-4: BACnet Objects – BST Manager Only – Object Type = AV, Read/Write						
BACnet ID	Object Name	Min	Max	BMK Edge[ii]	BMK Edge[i]	INN Edge[i]
223	onAER Mode	0 = Disabled 1 = Ethernet	2 = Wi-Fi 3 = Wiznet			
224	AERtrim	0 = Disabled, 1 = Enabled				NA
225	O2 Monitoring	0 = No, 1 = Yes		NA	NA	NA
226	SmartPlate Setpoint	0	NA			NA
227	SP Pump Out Signal	0	NA			NA
228	SmartPlate Pmp Unit Addr	0	NA			NA
229	Remote Disable Code (Advanced Setup → Comm & Network → BAS, Allow System Disable = Yes)	0 = Enable Plant	85 = Disable Plant			

4.2.3 BACnet Objects – BST Client Info Thru BST Manager

The BACnet objects listed below are all read-only from up to 16 BST units, which includes the unit designated as the BST Manager. They are divided into 16 sections, which are identical except for the BACnet ID. The BACnet ID pattern is as follows:

- 300 to 319 applies to the 1st BST/WHM unit
- 400 to 419 applies to the 2nd BST/WHM unit
- < Patter repeats up to >
- 1800 to 1819 applies to the 16th BST/WHM unit

TABLE 4-5: BACnet Objects – BST Client Info Thru BST Manager – Object Type = AI, Read Only						
BACnet IDs	Object Name	Min	Max	BMK Edge[ii]	BMK Edge[i]	INN Edge[i]
300, 400, 500 ... 1800	Communication Address	0	255			
301, 401, 501 ... 1801	unit Status	0 = Disabled 1 = Standby 2 = Manual	3 = Remote 4 = Auto 5 = Fault			
302, 402, 502 ... 1802	Fault Code	See Table 1 in Section 6: Fault/Status Codes				
303, 403, 503 ... 1803	Outlet Temperature	0	250F			
304, 404, 504 ... 1804	FFWD Temperature	0	250F			
305, 405, 505 ... 1805	Inlet Temperature	0	250F			
306, 406, 506 ... 1806	Exhaust Temperature	50F	450F			
307, 407, 507 ... 1807	Inlet Air Temperature	-70	130F			
308, 408, 508 ... 1808	Flame Strength	0	100%			
309, 409, 509 ... 1809	Fire Rate In	0	100%			
310, 410, 510 ... 1810	Fire Rate Out	0	100%			

SECTION 4: BAS (BACnet)

TABLE 4-5: BACnet Objects – BST Client Info Thru BST Manager – Object Type = AI, Read Only						
BACnet IDs	Object Name	Min	Max	BMK Edge[ii]	BMK Edge[i]	INN Edge[i]
311, 411, 511 ... 1811	Unit Type	0 = KC Boiler 1 = KC Boiler LN 2 = BMK Boiler Std 3 = BMK Blr Std Dual 4 = BMK Boiler LN 5 = BMK Blr LN Dual	6 = KC Water Heater 7 = KC Water Heater LN 8 = Innovation 9 = Innovation N			
312, 412, 512 ... 1812	Unit Size	0 = SPARE 1 = 600 MBH 2 = 800 MBH 3 = 1060 MBH 4 = 1350 MBH 5 = 500 MBH 6 = 750 MBH 7 = 1000 MBH 8 = 1.5 MBTU	9 = 1500 MBH 10 = 2.0 MBTU 11 = 2000 MBH 12 = 2500 MBH 13 = 3.0 MBTU 14 = 3000 MBH 15 = 4000 MBH 16 = 5000 MBH 17 = 6000 MBH			
313, 413, 513 ... 1813	Valve State	close	open			
314, 414, 514 ... 1814	Net Remote Setpoint	0	9999			
315, 415, 515 ... 1815	Run Cycle Upper	0	999,999,999			
316, 416, 516 ... 1816	Run Cycle Lower	0	999,999,999			
317, 417, 517 ... 1817	Run Hours Upper	NA	NA			
318, 418, 518 ... 1818	Run Hours Lower	NA	NA			
319, 419, 519 ... 1819	Oxygen Lvel	0	24%			NA

4.2.4 BACnet Point List – SmartPlate and SmartPlate EV

Table 4-6 lists the BACnet objects from up to 6 SmartPlate or SmartPlate EV units. They are divided into 6 sections (one per SmartPlate unit), which are identical except for the BACnet IDs. The BACnet IDs conform to the following pattern:

- Address 3500 to 3507 applies to the 1st SmartPlate unit
- Address 3600 to 3607 applies to the 2nd SmartPlate unit
- < Pattern repeats up to >
- Address 4000 to 4007 applies to the 6th SmartPlate unit

TABLE 4-6: BACnet Point List – SmartPlate and SmartPlate EV											
BACnet ID (Analog Inputs)						Object Name	Min	Max	BST Edge[ii]	BST Edge[i]	WHM
SmartPlate Unit # (of 6)											
1	2	3	4	5	6						
3500	3600	3700	3800	3900	4000	SP Outlet	°F (30 to 245)				NA
3501	3601	3701	3801	3901	4001	SP Valve Position	% (0 to 100)				NA
3502	3602	3702	3802	3902	4002	SP Setpoint	°F (30 to 245)				NA
3503	3603	3703	3803	3903	4003	SP Error #	Error # 0-20				NA

SECTION 4: BAS (BACnet)

3504	3604	3704	3804	3904	4004	SP Delta Pres **	PSI (0 to 100)			NA
3505	3605	3705	3805	3905	4005	SP DHW Inlet **	°F (-70 to 245)			NA
3506	3606	3706	3806	3906	4006	SP Flow **	GPM (0 to 200)			NA
3507	3607	3707	3807	3907	4007	SP Boiler Inlet	°F (30 to 245)			NA

*** Only applicable for SmartPlate EV*

SmartPlate’s starting address can be between 50-55. Even though the starting address is changed, the offset “xx” will stay the same.

SmartPlate Starting Address:

- #50, ‘xx’ = 35
- #51, ‘xx’ = 36
- #52, ‘xx’ = 37
- #53, ‘xx’ = 38
- #54, ‘xx’ = 39
- #55, ‘xx’ = 40

SECTION 5: BAS (Modbus)

- The Edge can be attached to an RS-485 Modbus bus and operate as an ACS client.
- The Edge presents the same Input and Holding Register variables to an ACS as the C-More.
- Test that the Edge Modbus Password can be set to the same Modbus password as the C-More.

5.1 Communication Specification

TBD

5.2 Modbus Point List

Modbus communication point list are in the following Sections, below:

5.2.1 – Modbus Point List – Stand-Alone or BST Client

5.2.2 – Modbus Point List – BST Manager Only

5.2.3 – Modbus Point List – Client Info Thru Manager

5.2.1 Modbus Point List – Stand-Alone or BST Client

TABLE 5-1: Modbus Point List – Stand-Alone or BST Client – Reg Type = Input Register						
Modbus Address	Object Name	Min	Max	BMK Edge[ii]	BMK Edge[i]	INN Edge[i]
30001	Message Code	0	100			
30002	Unit Status	0 = Disabled 1 = Standby 2 = Manual	3 = Remote 4 = Auto 5 = Fault			
30003	Outlet:	0	250F			
30004	Lower Inlet:	0	250F			
30005	Air Inlet:	-70	130F			
30006	Outside Temp:	-70	130F			
30007	Exhaust:	50	450			
30008	Feed Forward:	0	250F			
30009	Current Valve Position:	0	100			
30010	O2:	0	24.00%			NA
30011	Supply Gas Pressure:	Unused except for C-More compatibility		NA	NA	NA
30013	Run Cycles:	0	999,999,999			
30015	Run Hours:	0	999,999,999			
30016	Flame Strength:	0	100%			
30017	Active Setpoint Temp:	0	250F			

SECTION 5: BAS (Modbus)

TABLE 5-1: Modbus Point List – Stand-Alone or BST Client – Reg Type = Input Register						
Modbus Address	Object Name	Min	Max	BMK Edge[ii]	BMK Edge[i]	INN Edge[i]
30018	PID Output	0	100%			
30019	SET Valve Position	0	100			
30044	Communication Address:	0	255			
30045	Select Output:	0 = Standard Setup 1 = Cascade Valve 2 = Aout 2				
30046	Control Mode:	0 = On/Off 1 = Linear Modulation 2 = Delta T Modulation				
30047	Isolation Feedback:	disable	enable			
30048	Open Vlv Control Signal:	0 = 0mA 1 = 4mA 2 = 20mA				
30049	Close Vlv Control Signal:	0 = 0mA 1 = 4mA 2 = 20mA				
30050	Blower Speed	0	65536		NA	NA
30051	Blower Pulses/Rev:	0	100		NA	NA
30052 to 30059	O2 Target 1 to O2 Target 8	3%	8%			NA
30060	O2 Error Code1	Available in BACnet only		NA	NA	NA
30061	O2 Error Code2	Available in BACnet only		NA	NA	NA
30062	O2 Timer	0 = 2 Hour On 1 = 4 Hour On 2 = 10 Hour Off (Only for BNM version v05.09.020 or below)		NA	NA	NA
30063	bst uart3 errors	0 = No errors 1 = Overrun Error 2 = Framing Error 3 = Parity Error 4 = Uart Sync Error 5 = CRC Error 6 = Unknown Error				
30064	Nox Requirement	0	200			
30065	Manifold Gas Pressure	0	90			
30066 to 30073	O2 at Cal Point 1 to O2 at Cal Point 8	0	99.9			
30074 to 30081	NOx at Cal 1 to NOx at Cal 8	0	999			
30082 to 30089	CO at Cal 1 to CO at Cal 8	0	999			
30090 to 30097	Flame Strength at Cal 1 to Flame Strength at Cal 8	0	99.9			
30098	Time	12.00am	11.59pm			

SECTION 5: BAS (Modbus)

TABLE 5-1: Modbus Point List – Stand-Alone or BST Client – Reg Type = Input Register						
Modbus Address	Object Name	Min	Max	BMK Edge[ii]	BMK Edge[i]	INN Edge[i]
30099	Date	0/0/0	12/31/9999			
30100 to 30107	Previous O2 at Cal 1 to Previous O2 at Cal 8	0	99.9			
30108 to 30115	Previous NOx at Cal 1 to Previous NOx at Cal 8	0	999			
30116 to 30123	Previous CO at Cal 1 to Previous CO at Cal 8	0	999			
30124 to 30131	Previous CAL Point 1 to Previous CAL Point 8	0	100			
30132 to 30139	Pre Flame Strength at Cal 1 to Pre Flame Strength at Cal 8	0	99.9			
30140	SmartPlate Outlet	0	250F			NA
30141	SmartPlate Valve Pos	0	100			NA
30142	SmartPlate Setpoint	0	200F			NA
30143	SmartPlate Error Number	0	5			NA
30144	SmartPlate Pmp Unit Addr	0	255			NA
30145	SmartPlate Start Address	50	54			NA
30146	Number of SmartPlates	0	6			NA
30147	Current Blower Voltage	0	10v			
30148	Software Version	00.00.000	99.99.999			
30149	Unit Alpha	0=E, 1=G, 2=H, 3=R, 4=N, 5=A				
30150	Unit Year	0	99			
30151	Unit Serial #	0	9999			
30152	Fuel Type	0=Natural Gas, 1=Propane				
30153	Unit Mode	0= OFF, 1=Client, 2=Manager				

TABLE 5-2: Modbus Point List – Stand-Alone or BST Client – Reg Type = Holding Register						
Modbus Address	Object Name	Min	Max	BMK Edge[ii]	BMK Edge[i]	INN Edge[i]
40001	Net Remote Setpt	0	9999			
40002	Net Direct Drive	0	9999			NA
40003	Remote Password	0, 1, 2, 3, 4, 5				
40004	Password	0, 1, 2, 3, 4, 5				

SECTION 5: BAS (Modbus)

TABLE 5-2: Modbus Point List – Stand-Alone or BST Client – Reg Type = Holding Register						
Modbus Address	Object Name	Min	Max	BMK Edge[ii]	BMK Edge[i]	INN Edge[i]
40005	SH Setpoint:	20F	245F			
40006	Language:	0 = English, 1 = Spanish, 2 = French				
40007	Time:	12.00am	11.59pm			
40008	Date:	0/0/0	12/31/9999			
40009	Unit of Measurement:	English	Metric			
40010	Cascade Baud Rate	0 = 9600 1 = 19200 2 = 38400 3 = 115200				
40011	Unit Type:	0 = KC Boiler 1 = KC Boiler LN 2 = BMK Boiler Std 3 = BMK Blr Std Dual 4 = BMK Boiler LN 5 = BMK Blr LN Dual 6 = SmartPlate 7 = Other				
40012	Unit Size:	0 = SPARE 1 = 600 MBH 2 = 800 MBH 3 = 1060 MBH 4 = 1350 MBH 5 = 500 MBH 6 = 750 MBH 7 = 1000 MBH 8 = 1.5 MBTU 9 = 1500 MBH 10 = 2.0 MBTU 11 = 2000 MBH 12 = 2500 MBH 13 = 3.0 MBTU 14 = 3000 MBH 15 = 4000 MBH 16 = 5000 MBH 17 = 6000 MBH				
40013	SH Operating Mode	0 = Constant Setpt 1 = Remote Setpt 2 = Direct Drive 3 = Combination 4 = Outdoor Reset				
40016	Remote Signal	0 = 4-20mA/1-5V 1 = 0-20mA/0-5V 2 = Network 3 = BAS 4 = BST (PWM) Input				
40017	Outdoor Sensor	Disable	Enable			NA
40018	Warm Weather Shtdwn:	30F	210F			NA
40019	Setpoint Low Limit:	40F	245F			
40020	Setpoint High Limit:	20F	220F			
40021	Temperature High Limit:	40F	210F			
40022	Max Valve Position:	40	100			
40023	Pump Off Delay	0	30			

SECTION 5: BAS (Modbus)

TABLE 5-2: Modbus Point List – Stand-Alone or BST Client – Reg Type = Holding Register						
Modbus Address	Object Name	Min	Max	BMK Edge[ii]	BMK Edge[i]	INN Edge[i]
40024	Auxiliary Delay:	0	240			
40025	Unit Failsafe Mode	0 = Shutdown, 1 = Constant Setpt				
40026	Low Fire Timer:	2sec	600Sec			
40027	Proportional Band:	1F	120F			
40028	Integral Band:	0	2			
40029	Derivative Band:	0	2min			
40030	Min Load Adj	-50	50F	NA	NA	
40031	Max Load Adj	-50	50F	NA	NA	
40032	Outlet Feedback	No	Yes	NA	NA	
40033	Feedback Gain	0.01	1	NA	NA	
40034	Breakpt at 0%	-100	100F	NA	NA	
40035	Breakpt at 10%	-100	100F	NA	NA	
40036	Breakpt at 20%	-100	100F	NA	NA	
40037	Breakpt at 30%	-100	100F	NA	NA	
40038	Breakpt at 40%	-100	100F	NA	NA	
40039	Breakpt at 50%	-100	100F	NA	NA	
40040	Breakpt at 60%	-100	100F	NA	NA	
40041	Breakpt at 70%	-100	100F	NA	NA	
40042	Breakpt at 80%	-100	100F	NA	NA	
40043	Breakpt at 90%	-100	100F	NA	NA	
40044	Breakpt at 100%	-100	100F	NA	NA	
40045	Purge Timer:	5Sec	60Sec			
40046	Post Purge Timer:	0	60Sec			
40047	Ignition Position:	5%	60%			
40048	Stop Valve Position:	0	40%			
40049	Start Valve Position:	0	40%			
40050	On Delay:	0	600Sec			
40053	Max Flow	10gpm	500gpm			
40054	FFWD Temp Display	Disable	Enable			
40057	Flow Rate Disply	Disable	Enable			
40058	Valve Pos Out Dsp	Disable	Enable			
40059	Exhaust Temp Dsp	Disable	Enable			
40060	Setpoint Limiting:	Disable	Enable			
40061	Setpoint Limit Band:	0	10F			
40062	Temp Comp Adjust	None	Run Cycles			
40063	Inlet Temp Display	Disable	Enable			
40064	Power Reset:	Manual	Automatic			
40065	Water Temp Reset:	Manual	Automatic			
40066	Gas Pressure Reset:	Manual	Automatic			

SECTION 5: BAS (Modbus)

TABLE 5-2: Modbus Point List – Stand-Alone or BST Client – Reg Type = Holding Register						
Modbus Address	Object Name	Min	Max	BMK Edge[ii]	BMK Edge[i]	INN Edge[i]
40070	Sensor Log Int	0 = Off 1 = 1 min 2 = 5 min 3 = 15 min 4 = 30 min	5 = 1 hr 6 = 6 hrs 7 = 12 hrs 8 = 24 hrs			
40071	BAS:	0 = Off 1 = BACnet MSTP 2 = BACnet IP 3 = Modbus RTU 4 = Modbus TCP				
40072	Cascade Baud Rate	0 = 9600 1 = 19200 2 = 38400	3 = 57600 4 = 76800 5 = 115200			
40073	INTL Communication	Disable	Enable			
40074	Intl Baud Rate	0 = 9600 1 = 19200	2 = 38400 3 = 57600			
40075	onAER Menu	0 = Disabled 1 = Ethernet 2 = Wi-Fi 3 = Wiznet				
40076	AERtrim	Disabled	Enabled			NA
40077	O2 Monitoring:	Applicable with BMK v05.09.020 or before		NA	NA	NA
40078	SmartPlate Setpoint:	0	140F			NA
40079	SP Pump Out Signal	0	10V			NA
40080	SmartPlate Pmp Unit Addr	Disabled	Enabled			
40081	Remote Disable Code (Advanced Setup → Comm & Network → BAS, Allow System Disable = Yes)	0 = Enable Unit 85 = Disable Unit				
40082	Outdoor Air Temp Sens	0=Network, 1=Direct, 2=BAS				NA
40083	OAT BAS Temp	0	250F			NA

SECTION 5: BAS (Modbus)

5.2.2 Modbus Point List – BST Manager Only

TABLE 5-3: Modbus Point List – BST Manager Only – Reg Type = Input Register

Modbus Address	Object Name	Min	Max	BMK Edge[ii]	BMK Edge[i]	INN Edge[i]
30100	Unit Mode:	0 = off, 1= BST Client, 2= BST Manager				
30101	Plant Constant Setpoint:	20F	245F			
30102	Setback Setpoint:	20F	245F			
30103	Setback Start Time:	12.00am	11.59pm			
30104	Setback Stop Time:	0/0/0	12/31/9999			
30105	Auto-Manager Transfer:	Disabled	Enabled			
30106	OutletTemp	0F	250F			
30107	UEnabled	0	16			
30108	Units Faulted	0	16			
30109	Unit Address:	0	16			
30110	Header Temp	0F	250F			NA
30111	BST Outdoor Temp	-70	130F			NA
30112	BST Fire Rate	0	100%			NA
30113	Units Ignited	0	16			
30114	Act Setpt	0F	250F			
30115	SH Next On Valve Pos:	16%	100%			NA
30116	BST Setpt Hi Lim	20F	220F			NA
30117	BST Setpt Low Limit:	40F	245F			NA
30118	Cascade Temp Hi Limit:	40F	210F			
30119	SH Operating Mode	0 = Constant Setpoint 1 = Rmt Stpt 2 = Outdoor Air Reset				
30120	DHW Header Temp	0	245F		NA	NA
30121	DHW Setpoint	40F	245F		NA	NA
30122	Fuel Type	0=Natural Gas, 1=Propane				
30123	VSP Pump Output	0V	10V		NA	NA
30124	VSP Pump Relay	Off	On		NA	NA
30125	Loop Return Temp	40F	245F		NA	NA
30126	DHW Header Temp	40F	245F		NA	NA
30127	SmartPlate Outlet	40F	245F			NA
30128	SmartPlate Valve Pos	0%	100%			NA
30129	SmartPlate Setpoint	0F	140F			NA
30130	SmartPlate Error Number	0	10			NA

SECTION 5: BAS (Modbus)

TABLE 5-3: Modbus Point List – BST Manager Only – Reg Type = Input Register						
Modbus Address	Object Name	Min	Max	BMK Edge[ii]	BMK Edge[i]	INN Edge[i]
30131	SmartPlate Pmp Unit Addr	0	16			NA
30132	SmartPlate Start Address	50	54			NA
30133	Number of SmartPlates	0	6			NA
30134-30151	Not In Use					
30152	Unit Mode (For BACnet only)	0=OFF, 1=Client, 2=Manager				
30153	Unit Mode	0=OFF, 1=Client, 2=Manager				

TABLE 5-4: Modbus Point List – BST Manager Only – Reg Type = Holding Register							
Modbus Address	Object Name	Min	Max	BMK Edge[ii]	BMK Edge[i]	INN Edge[i]	
40051	Allow BAS to Write	0	1	NA	NA	NA	
40053	Network Timeout:	5sec	999sec				
40200	Plant Remote Setpoint:	20F	245F				
40201	Setback Setpoint:	20F	245F				
40202	Setback Start Time:	12.00am	11.59pm				
40203	Setback Stop Time:	12.00am	11.59pm				
40204	Setback Schedule:	Disable	Enable				
40205	DHW Temp Sensor:	0 = OFF, 1 = Network, 2 = Direct, 3 = BAS				NA	NA
40206	DHW Header Temp:	0F	250F		NA		
40207	DHW Operating Mode:	0 = Constant Setpoint, 1 = Remote Setpoint				NA	
40208	DHW Rmt Setpt Signal:	0 = 1-5V, 1 = 0-5V, 2 = Network, 3 = BAS				NA	
40209	DHW BAS Remote Setpoint	40F	245F		NA		
40210	Other SH PRI Setpt Mode	0 = Constant Setpoint, 1 = Remote Setpoint				NA	NA
40211	Other SH PRI Remote Signl	0 = 1-5V, 1 = 0-5V, 2 = Network, 3 = BAS				NA	NA
40212	Other SH PRI Setpoint	20F	245F		NA	NA	
40213	Hdr Temp Sensor	0 = Network 1 = FFWD Temp 2 = Direct		3 = BAS 4 = OFF		NA	
40214	BAS Header Temp	0F	250F			NA	
40215	Rtn Hdr Temp Sensor	OFF(0), Network(1), Direct(2), BAS(3)					NA

SECTION 5: BAS (Modbus)

TABLE 5-4: Modbus Point List – BST Manager Only – Reg Type = Holding Register						
Modbus Address	Object Name	Min	Max	BMK Edge[ii]	BMK Edge[i]	INN Edge[i]
40216	Rtn Hdr Temp Sensor	0F	250F			NA
40217	Outdoor Air Temp Sens	Network(0), Direct(1), BAS(2), OFF(3)				NA
40218	OAT BAS Temp	0F	250F			NA
40219	BAS	0 = OFF 1 = BACnet MSTP 2 = BACnet IP 3 = Modbus RTU 4 = Modbus TCP				
40220	Baud Rate	0 = 9600 1 = 19200	2 = 38400 3 = 57600			
40221	INTL Communication	0 = Disabled 1 = Enabled				
40222	Intl Baud Rate	0 = 9600 1 = 19200	2 = 38400 3 = 57600			
40223	onAER Mode	0 = Disabled 1 = Ethernet	2 = Wi-Fi 3 = Wiznet			
40224	AERtrim	0 = Disabled, 1 = Enabled				NA
40225	O2 Monitoring	0 = No, 1 = Yes		NA	NA	NA
40226	SmartPlate Setpoint	0	140F			NA
40227	SP Pump Out Signal	0	10V			NA
40228	SmartPlate Pmp Unit Addr	0	255			NA
40229	Remote Disable Code (Advanced Setup → Comm & Network → BAS, Allow System Disable = Yes)	0 = Enable Plant 85 = Disable Plant				

5.2.3 Modbus Point List – BST Client Info Thru BST Manager

Table 5-5 lists the Modbus addresses, all read-only, from up to 16 BST, which includes the unit designated as the BST Manager. They are divided into 16 sections, which are identical except for the Modbus addresses. The Modbus address pattern is as follows:

- Address 30300 to 30319 applies to the 1st BST unit
- Address 30400 to 30419 applies to the 2nd BST unit
- < Patter repeats up to >
- Address 31800 to 31819 applies to the 16th BST unit

For example, the Modbus address of Unit Status for BST unit # 3 is 30501.

SECTION 5: BAS (Modbus)

TABLE 5-5: Modbus Point List – BST Client Info Thru BST Manager – Reg Type = Input Register						
Modbus Address	Object Name	Min	Max	BMK Edge[ii]	BMK Edge[i]	INN Edge[i]
30300, 30400, 30500 ... 31800	Communication Address	0	255			
30301, 30401, 30501 ... 31801	Unit Status	0 = Disabled 1 = Standby 2 = Manual	3 = Remote 4 = Auto 5 = Fault			
30302, 30402, 30502 ... 31802	Fault Code	See Table 1 in Section 6: Fault/Status Codes				
30303, 30403, 30503 ... 31803	Outlet Temperature	0	250F			
30304, 30404, 30504 ... 31804	FFWD Temperature	0	250F			
30305, 30405, 30505 ... 31805	Inlet Temperature	0	250F			
30306, 30406, 30506 ... 31806	Exhaust Temperature	50F	450F			
30307, 30407, 30507 ... 31807	Inlet Air Temperature	-70	130F			
30308, 30408, 30508 ... 31808	Flame Strength	0	100%			
30309, 30409, 30509 ... 31809	Fire Rate In	0	100%			
30310, 30410, 30510 ... 31810	Fire Rate Out	0	100%			
30311, 30411, 30511 ... 31811	Unit Type	0 = KC Boiler 1 = KC Boiler LN 2 = BMK Boiler Std 3 = BMK Blr Std Dual 4 = BMK Boiler LN 5 = BMK Blr LN Dual	6 = KC Water Heater 7 = KC WaterHeater LN 8 = Innovation 9 = Innovation N			
30312, 30412, 30512 ... 31812	Unit Size	0 = SPARE 1 = 600 MBH 2 = 800 MBH 3 = 1060 MBH 4 = 1350 MBH 5 = 500 MBH 6 = 750 MBH 7 = 1000 MBH 8 = 1.5 MBTU	9 = 1500 MBH 10 = 2.0 MBTU 11 = 2000 MBH 12 = 2500 MBH 13 = 3.0 MBTU 14 = 3000 MBH 15 = 4000 MBH 16 = 5000 MBH 17 = 6000 MBH			
30313, 30413, 30513 ... 31813	Valve State	close	open			
30314, 30414, 30514 ... 31814	Net Remote Setpoint	0	9999			
30315, 30415, 30515 ... 31815	Run Cycle Upper	0	999,999,999			
30316, 30416, 30516 ... 31816	Run Cycle Lower	0	999,999,999			
30317, 30417, 30517 ... 31817	Run Hours Upper	NA	NA			
30318, 30418, 30518 ... 31818	Run Hours Lower	NA	NA			

SECTION 5: BAS (Modbus)

Modbus Address	Object Name	Min	Max	BMK Edge[ii]	BMK Edge[i]	INN Edge[i]
30319, 30419, 30519 ... 31819	Oxygen Level	0	24%			NA

5.2.4 Modbus Point List – SmartPlate and SmartPlate EV

Table 5-6 lists the Modbus addresses from up to 6 SmartPlate or SmartPlate EV units. They are divided into 6 sections (one per SmartPlate unit), which are identical except for the Modbus addresses. The Modbus addresses conform to the following pattern:

- Address 33500 to 33507 applies to the 1st SmartPlate unit
- Address 33600 to 33607 applies to the 2nd SmartPlate unit
- < Pattern repeats up to >
- Address 34000 to 34007 applies to the 6th SmartPlate unit

Modbus Address (Input Registers)						Object Name	Min	Max	BST Edge[ii]	BST Edge[i]	WHM
SmartPlate Unit # (of 6)											
1	2	3	4	5	6						
33500	33600	33700	33800	33900	34000	SP Outlet	°F (30 to 245)			NA	NA
33501	33601	33701	33801	33901	34001	SP Valve Position	% (0 to 100)			NA	NA
33502	33602	33702	33802	33902	34002	SP Setpoint	°F (30 to 245)			NA	NA
33503	33603	33703	33803	33903	34003	SP Error #	Error # 0-20			NA	NA
33504	33604	33704	33804	33904	34004	SP Delta Pres **	PSI (0 to 100)			NA	NA
33505	33605	33705	33805	33905	34005	SP DHW Inlet **	°F (-70 to 245)			NA	NA
33506	33606	33706	33806	33906	34006	SP Flow **	GPM (0 to 200)			NA	NA
33507	33607	33707	33807	33907	34007	SP Boiler Inlet	°F (30 to 245)			NA	NA

** Only applicable for SmartPlate EV

SmartPlate’s starting address can be between 50-55. Even though the starting address is changed, the offset “xx” will stay the same.

SmartPlate Starting Address:

- #50, ‘xx’ = 35
- #51, ‘xx’ = 36
- #52, ‘xx’ = 37
- #53, ‘xx’ = 38
- #54, ‘xx’ = 39
- #55, ‘xx’ = 40

SECTION 5: BAS (Modbus)

SmartPlate Error Numbers:

Fault #	Description
1	* High Temperature Warning
2	* Max Temperature Limit
3	Communication Error
4	Non-Compatible Heater
5	Pump Unit Feedback Error
6	Temperature deviation high
7	Temperature deviation low
8	Flow Sensor error (a sensor break condition)
9	Boiler Water In sensor error
10	DHW out sensor error
11	DHW in sensor error
23	BW Temp In < DHW SP
13	Pressure sensor error

* *Warning is not applicable for SmartPlate EV*

SECTION 6: Fault/Status Codes

The Edge Controller displays the following status messages when appropriate. The # column lists the corresponding code returned to Building Automation Systems.

Four types of messages can appear on the Edge Controller's display screen:

- **Message:** Information about a current event or condition: no intervention required.
- **Warning:** An abnormal event or condition occurred, but the unit continues to operate normally: no intervention required.
- **Fault:** An abnormal event or condition occurred that caused the unit to shut down. The unit will restart automatically once the cause of the fault is resolved.
- **Fault, Reset:** An abnormal event or condition occurred that caused the unit to shut down. A corrective action may be required. Once the cause of the fault is resolved, the Controller's **CLEAR** button must be pressed manually to restart the unit.

TABLE 6: Fault Codes

Code	Message	Message Type	Description
0	NO FAULTS	n/a	
1	Disabled	Message	Indicates the Enable/Disable switch is set to Disabled . The display also shows the time (AM or PM) and date that the unit was disabled.
2	Standby	Message	Displayed when ON/OFF switch is in the ON position, but there is no demand for heat. The time and date are also displayed.
3	Demand Delay	Message	Displayed if Demand Delay is active.
4	Purging	Message	Displayed during the purge cycle during startup. The duration of the purge cycle counts up in seconds.
5	Ignition Trial	Message	Displayed during ignition trial of startup sequence. The duration of cycle counts up in seconds.
6	Flame Proven	Message	Displayed after flame has been detected for a period of 2 seconds. Initially, the flame strength is shown in %. After 5 seconds has elapsed, the time and date are shown in place of flame strength.
7	Warmup	Message	Displayed for 2 minutes during the initial warm-up only.
8	High Water Temp Switch Open	Fault, Reset	The High Water Temperature Limit Switch is open.
9	Low Water Level	Fault, Reset	The Water Level Control board is indicating low water level.
10	Low Gas Pressure Fault	Fault, Reset	The Low Gas Pressure Limit Switch is open.
11	Gas Pressure Fault	Fault, Reset	The High Gas Pressure Limit Switch is open.
12	Interlock Open	Fault	The Remote Interlock is open.
13	Delayed Interlock Open	Fault, Reset	The Delayed Interlock is open.
14	Airflow Fault During Purge	Fault, Reset	The Blower Proof Switch opened during purge.
15	SSOV Fault During Purge	Fault, Reset	The SSOV switch opened during purge.
16	Prg Switch Open During Purge	Fault, Reset	The Purge Position Limit switch on the Air/Fuel valve opened during purge.

SECTION 6: FAULT/STATUS CODES

TABLE 6: Fault Codes			
Code	Message	Message Type	Description
17	Ign Switch Open During Ignition	Fault, Reset	The Ignition Position Limit switch on the Air/Fuel valve opened during ignition.
18	Airflow Fault During Ign	Fault	The Blower Proof Switch opened during ignition.
19	Airflow Fault During Run	Fault, Reset	The Blower Proof Switch opened during run.
20	SSOV Fault During Ignition	Fault, Reset	The SSOV switch closed or failed to open during ignition.
21	SSOV Fault During Run	Fault, Reset	The SSOV switch closed for more than 15 seconds during run.
22	Flame Loss During Ignition	Fault, Reset	The Flame signal was not seen during ignition or lost within 5 seconds after ignition.
23	Flame Loss During Run	Fault, Reset	The Flame signal was lost during run.
24	High Exhaust Temp Switch	Fault, Reset	The High Exhaust Temperature Limit Switch is closed.
25	Loss of Power	Fault	A power loss occurred. The time and date when power was restored is displayed.
26	Loss of Sensor	Not Used	Not Currently Used
27	Loss of Signal	Not Used	Not Currently Used
28	High O2 Level	Fault	Not Currently Used
29	Low O2 Level	Fault	Not Currently Used
30	High CO Level	Not Used	Not Currently Used
31	SSOV Relay Failure	Fault, Reset	A failure has been detected in one of the relays that control the SSOV.
32	Residual Flame	Fault, Reset	The Flame signal was seen for more than 60 seconds during standby.
33	Heat Demand Failure	Fault, Reset	The Heat Demand Relays on the Ignition board failed to activate when commanded.
34	Ign Switch Closed During Purge	Fault, Reset	The Ignition Position Limit switch on the Air/Fuel valve closed during purge.
35	Prg Switch Closed During Ign	Fault, Reset	The Purge Position Limit switch on the Air/Fuel valve closed during ignition.
36	SSOV Switch Open	Fault, Reset	The SSOV switch opened during standby.
37	Ign Board Comm Fault	Fault	Communication fault between the Ignition board and the CPU board.
38	Wait	Message	Prompts the operator to wait.
39	Direct Drive Signal Fault	Fault	The direct drive signal is not present or is out of range.
40	Remote Setpt Signal Fault	Fault	The remote setpoint signal is not present or is out of range.
41	Outdoor Temp Sensor Fault	Fault	The temperature measured by the Outdoor Air Sensor is out of range.
42	Outlet Temp Sensor Fault	Fault	The temperature measured by the Outlet Sensor is out of range.
43	FFWD Temp Sensor Fault	Fault	The temperature measured by the FFWD Sensor is out of range.
44	High Water Temp	Fault	The temperature measured by the Outlet Sensor exceeded the Temp Hi Limit setting.

SECTION 6: FAULT/STATUS CODES

TABLE 6: Fault Codes			
Code	Message	Message Type	Description
45	Line Voltage Out of Phase	Fault, Reset	The High AC voltage is out of phase from the low AC voltage.
46	Stepper Motor Failure	Fault, Reset	The stepper motor failed to move the valve to the desired position.
47	Setpoint Limiting Active	Fault	Setpoint temperature has exceeded the maximum allowable setting.
48	Modbus Comm Fault	Fault	The RS485 (Modbus) network information is not present or is corrupted.
49	Wait Ignition Retry	Message	Retrial for ignition.
50	WaitFault Purge	Message	Fault while purging.
51	Wait Retry Pause	Message	Pause before retrial for ignition.
52	Exhaust Temp Sensor Short	Warning	Exhaust temperature sensor is shorted.
53	Exhaust Temp Sensor Open	Warning	Exhaust temperature sensor is open or missing.
54	Warning Exhaust Temp High	Warning	Exhaust temperature is getting high.
55	Exhaust Temp High	Fault, Reset	Exhaust temperature is too high.
56	Inlet Water Temp Sensor Short	Warning	Inlet water temperature sensor is shorted.
57	Inlet Water Temp Sensor Open	Warning	Inlet water temperature sensor is open or missing.
58	Warning In Wtr Temp High	Warning	Inlet water temperature is getting too high.
59	Warning In Wtr Temp Low	Warning	Inlet water temperature is getting too low.
60	Inlet Gas Press Sensor Open	Fault	Inlet gas pressure switch is open.
61	Gas Plate Dp Sensor Open	Fault	Gas plate differential pressure switch is open.
62	O2 Percentage Low	Fault	Oxygen level is too low.
63	O2 Sensor Malfunction	Fault	Oxygen sensor reading is out of range.
64	Warning O2 Level High	Warning	Oxygen level is too high.
65	Recirc Pump Failure	Fault, Reset	Heater recirculation pump has malfunctioned.
66	Ignition Monitor	Message	Waiting for proof of ignition.
67	No Flow Saftey Lockout	Not used	Flow input not registering when boiler is starting up.
68	Ignition Spark Fault	Fault, Reset	No ignition current measured when igniter is energized.
69	Pre Ignition	Message	Waiting for SSOV to prove open.
70	Cleaning Igniter	Message	Ignition transformer is energized with SSOV closed.
71	Too Many Cycles In 24 Hours	Fault	The number of cycles in 24 hour period has been exceeded.
72	Too Many Overtmps In 24 Hours	Fault	The number of over temperature events in 24 hour period has been exceeded.
73	Air Sensor Fault	Fault	The inlet air sensor is out of range.
74	Auto Diagnostic Mode ACTIVE	Message	Informational message.
75	Auto Diagnostic Mode COMPLETED	Message	Informational message.
76	Auto Diagnostic Mode ABORTED	Message	Informational message.

SECTION 6: FAULT/STATUS CODES

TABLE 6: Fault Codes			
Code	Message	Message Type	Description
77	DHW Heating Active	Message	Domestic Hot Water is enabled. Message shows when in combo mode with a fault in the drive signal.
78	Boiler Cooling Off	Message	Informational message during slow shutdown mode.
79	BST Network Temp Sensor Fault	Fault	The BST Modbus header temperature sensor is out of range.
80	BST Network Temp Com Fault	Fault	The BST Modbus failed to read the header temperature sensor.
81	BST Local Header Sensor Fault	Fault	The BST direct connected header temperature sensor is out of range.
82	BST Net Outdoor Sensor Fault	Fault	The BST Modbus connected outdoor air temperature sensor is out of range.
83	BST Net Outdoor Com Fault	Fault	The BST Modbus device failed to read the outdoor air sensor.
84	BST Local Outdr Sensor Fault	Fault	The BST direct connected outdoor air temperature sensor is out of range.
85	BST Client Com Fault	Message	Communication between BST Manager and BST Client failed
86	O2 Cal Purge	Message	O2 Purge in progress
87	Auto Calibration In Progress	Message	Auto Calibration In Progress
88	Autocal Finished	Warning	Autocal Finished
89	O2 Sensor Out Of Range	Warning	O2 sensor reading is out of range
90	O2 Warning Service Required	Message	O2 service is required
91	Wait Sensor Warm-up	Warning	O2 sensor is warming up
92	Air Pump Failed O2 Trim Disabled	Fault	O2 Trim was disabled due to air pump failuer (BMK 5000-6000 only)
93	onAER Communication failed	Warning	onAER communication failed
94	Isolation Valve Stuck Open	Warning	Isolation Valve Stuck Open
95	Isolation Valve Stuck Closed	Fault	Isolation Valve Stuck Closed
96	Maintenance Overdue	Warning	Periodic maintenance is overdue
97	Maintenance Due Soon	Warning	Periodic maintenance will be due soon
98	BAS System Disable	Warning	BAS system is disabled
99	Delta-T Activated	Warning	Delta-T is activated
100	Delta-T Shutdown	Warning	Delta-T has shutdown
101	BackUp Manager is not Compatible	Warning	Designated BST BackUp Manager is not compatible
102	IO Board Communication Failed	Warning	Communication with the I/O board failed
103	SH Swing Valve Fault	Warning	Space Heating side swing valve failed
104	DHW Swing Valve Fault	Warning	Domestic hot water side swing valve failed
105	No BAS Communication	Warning	No communication from the Building Automation system after a period of 5 minutes
106	Warm Weather Shutdown	Warning	BST warm weather shutdown warning
107	Warm Weather Shutdown	Warning	Standalone warm weather shutdown warning
108	DHW Header Temp over BAS Fault	Warning	BAS failed to update the DHW temperature periodically

SECTION 6: FAULT/STATUS CODES

TABLE 6: Fault Codes			
Code	Message	Message Type	Description
109	BST Header Temp over BAS Fault	Warning	BAS failed to update the BST header temperature periodically
110	Supply Return Temp over BAS Fault	Warning	BAS failed to update the supply return temperature periodically
111	Outdoor Temp over BAS Fault	Warning	BAS failed to update the outdoor temperature periodically
112	BST Return Sensor Short Warning	Warning	BST return sensor is shorted. Check the wirings.
113	BST Return Sensor Open Warning	Warning	BST return sensor is disconnected
114	DHW Header Network Sensor Fault	Warning	DHW header network sensor temperature is out of range.
115	DHW Header Network Comm Fault	Warning	No communication response from the DHW header network sensor
116	Supply Return Network Sensor Fault	Warning	Supply Return Network Sensor temperature is out of range.
117	Supply Return Network Comm Fault	Warning	No communication response from the supply return network sensor



© AERCO International, Inc., 2023